

Metering pumps

Applicable to the many diverse needs
of chemical feeding

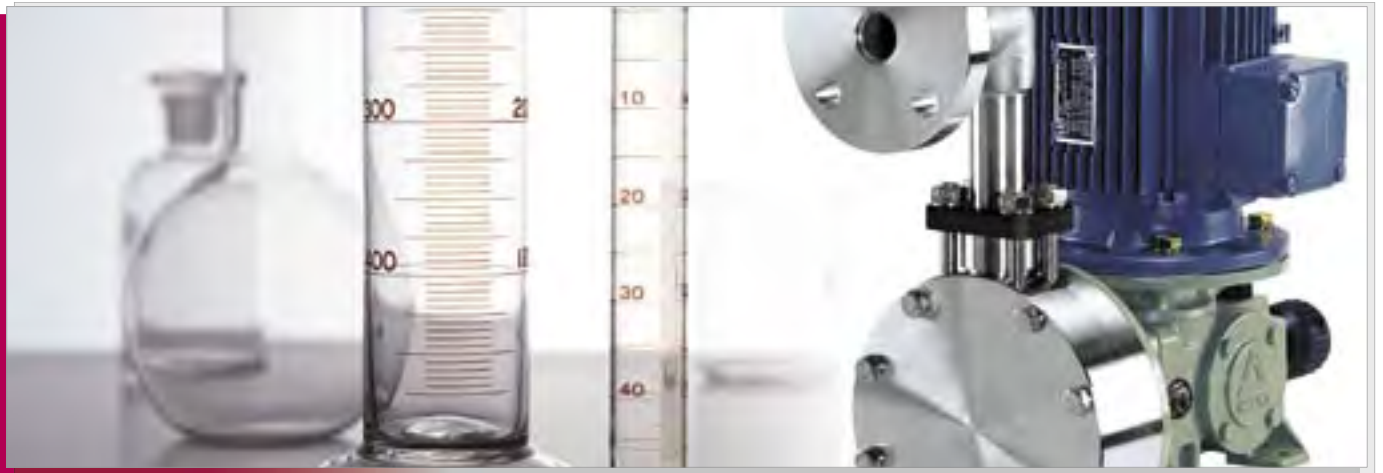

Iwaki's systematic LK series metering pump consists of the worm gear type dual-cam driving section, which is compact yet rigid and reliable, and wet-end materials of which there are seven types for various applications.

Applicable to the many diverse needs of chemical feeding

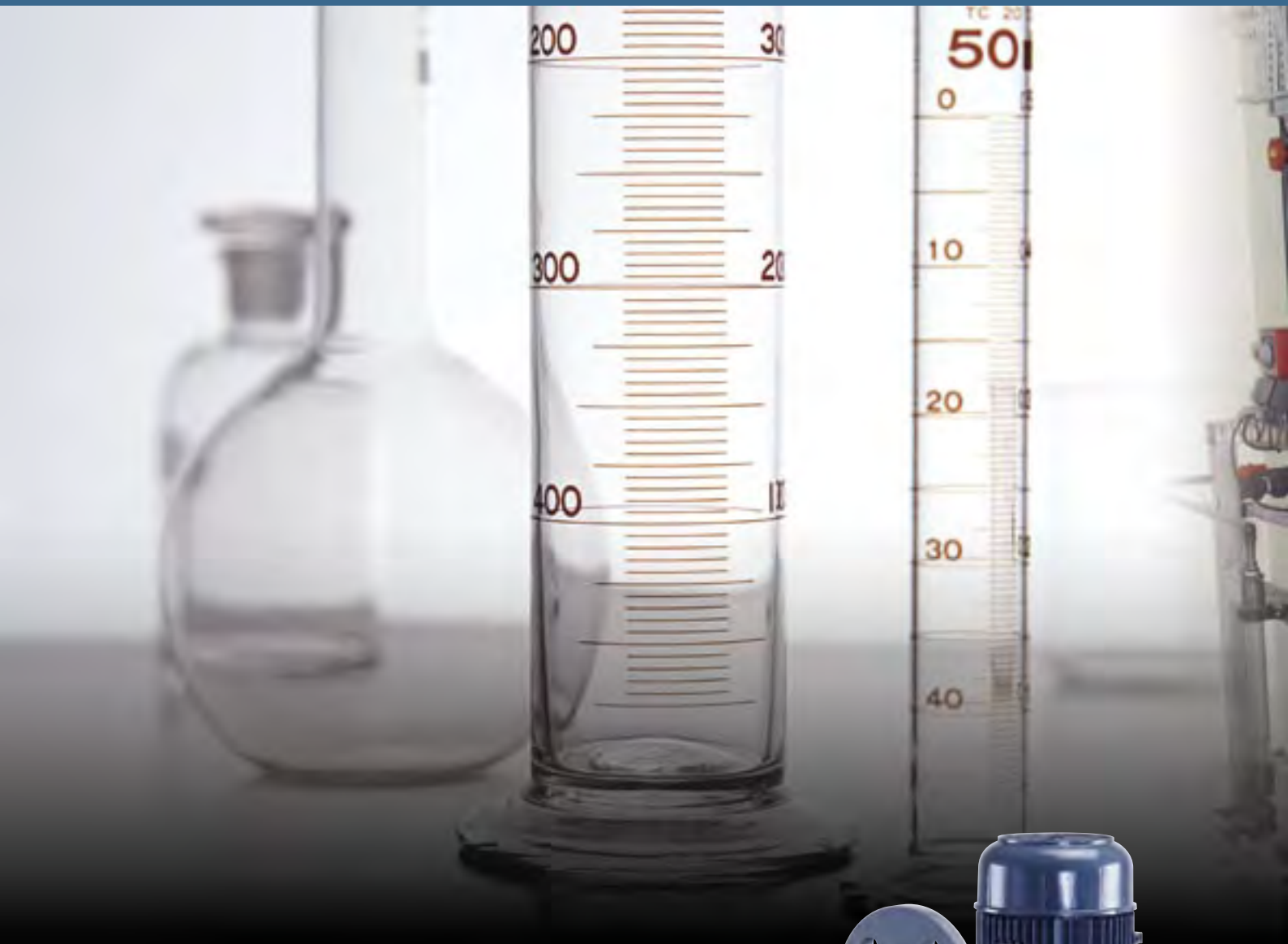

Iwaki's LK series metering pump consists of the worm gear type dual-cam driving section, which is compact yet rigid and reliable. With long and market-proven experience, Iwaki has employed state-of-the-art pump technologies in the development of an ideal type of chemical feeding pump which has advantages such as quality, performance, ease of operation and cost efficiency. The LK series is suitable for many chemical liquid feeding processes used in a wide range of fields, including water treatment, chemicals, fabrics, paper mill, food processing, and medicine.



LK-F57VCT



Various types and materials

The LK series is available to suit each user's needs in accordance with feeding rate from small to large capacity. Also, material variation has been improved. Selection of the pump material most suitable for the applied liquid is possible with six different types available.

High performance and application-oriented versatile design.

Discharge accuracy (stability) is within $\pm 2\%$ FS. Reliability is considerably enhanced through efforts to improve the linearity of the stroke / discharge ratio as well as the dispersion between stroke.

Two types of joints flange and hose joints are standardized for the connections. (LK-F11 to LK-F47) The optimum piping system can be selected.



LK-F57S6T



LK-C86VCT

Construction

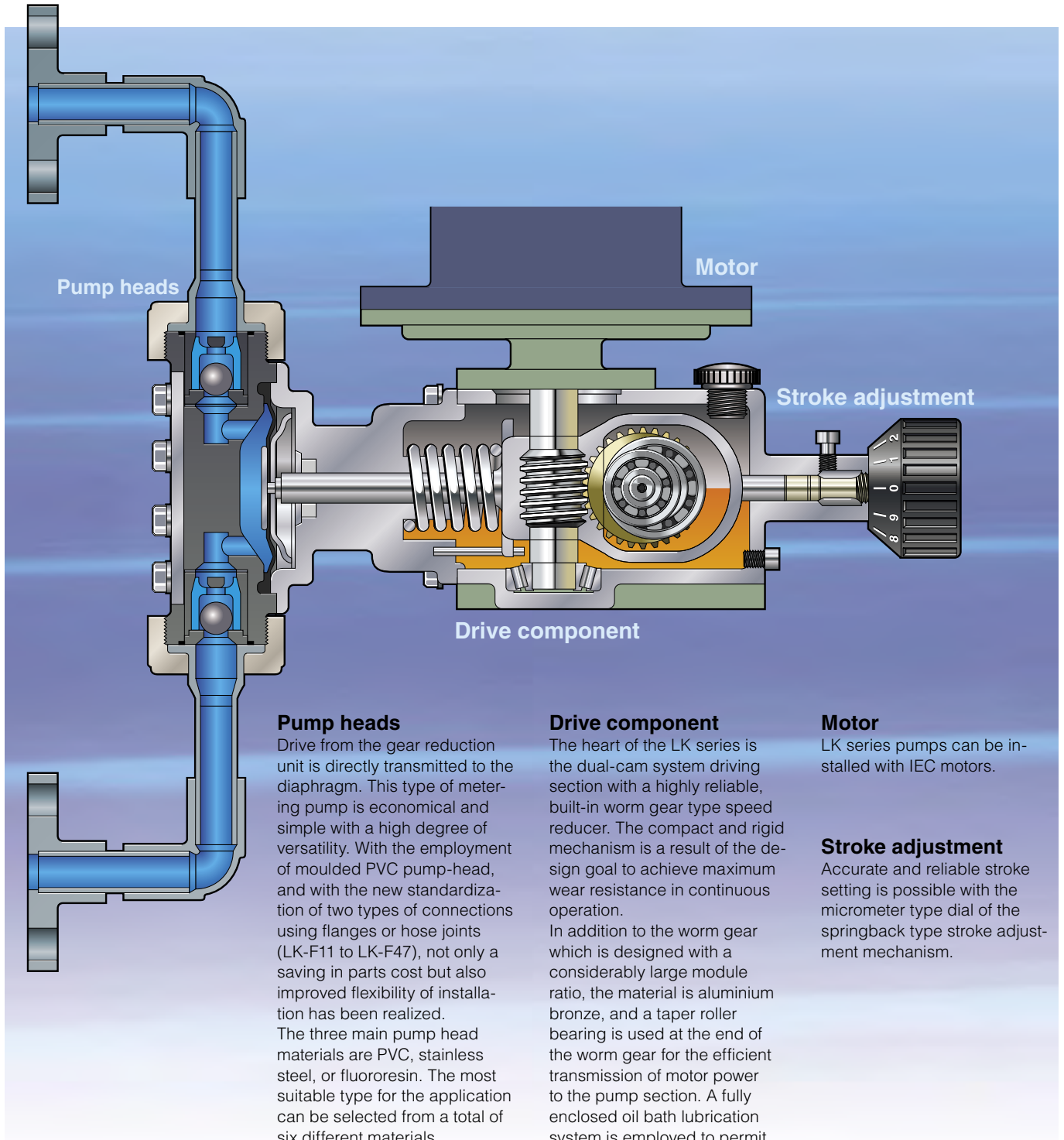

Pump heads

Drive from the gear reduction unit is directly transmitted to the diaphragm. This type of metering pump is economical and simple with a high degree of versatility. With the employment of moulded PVC pump-head, and with the new standardization of two types of connections using flanges or hose joints (LK-F11 to LK-F47), not only a saving in parts cost but also improved flexibility of installation has been realized. The three main pump head materials are PVC, stainless steel, or fluororesin. The most suitable type for the application can be selected from a total of six different materials.

Drive component

The heart of the LK series is the dual-cam system driving section with a highly reliable, built-in worm gear type speed reducer. The compact and rigid mechanism is a result of the design goal to achieve maximum wear resistance in continuous operation. In addition to the worm gear which is designed with a considerably large module ratio, the material is aluminium bronze, and a taper roller bearing is used at the end of the worm gear for the efficient transmission of motor power to the pump section. A fully enclosed oil bath lubrication system is employed to permit outdoor installation. The durability in continuous operation over a long period of time is also excellent.

Motor

LK series pumps can be installed with IEC motors.

Stroke adjustment

Accurate and reliable stroke setting is possible with the micrometer type dial of the springback type stroke adjustment mechanism.



Materials

Type	VC	VH	VS4	S6	S4		
Application	Acids	Alkalines		Solvents			
Applicable type	11 to 87	11 to 57	65 to 87	11 to 57	65 to 87		
Part	Pump head	PVC	PVC	PVC	SUS316	SCS13	
	Valve	CE	HC	SUS304	HC	SUS304	
	Valve seat	Type 11 to 32	FKM	EPDM	–	SUS316	–
		Type 45 to 87	PVC	PVC	PVC	SUS316	SUS304
	O ring	FKM	EPDM	EPDM	–	–	
Valve gasket	PTFE		–	PTFE			
Diaphragm	PTFE coated EPDM						
Liquid temp. range *	0 - 50°C			0 - 80°C			

* : Liquid temp. range is varied by handling chemical. Please contact us.

Typical chemicals	Material symbols
VC: Sulfuric acid, Hydrochloric acid, Sodium hypochlorite	SCS13: Stainless- cast steel equivalent to SUS304
VH, VS4: Caustic soda, Coagulant, Calcium hydroxide (low density)	CE: Ceramic
TC: Concentrated sulfuric acid, Hydrofluoric acid, Mixed acid	FKM: Fluoro rubber
S6,S4: Organic solvent, Paper making chemicals	HC: Hastelloy C276

Note : VS type for viscosity and slurry is available on special request. Please contact us for details.
For information of TC type, please contact IWAKI or nearest distributor.

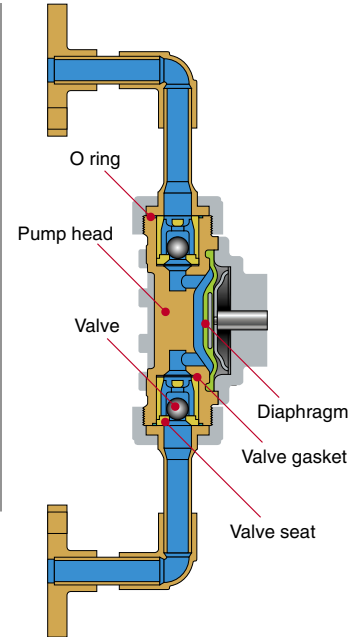

Identification

LK - F 32 VC T

- Series name**
LK series: Mechanical driven diaphragm type
- Drive section**
F: 0.25kW, A: 0.37kW, B: 0.75kW, C: 1.5kW
- Type No.**
First digit : Diaphragm (pump head size)
Second digit : Speed-reducing gear ratio 1: 1/30, 2: 1/15, 5: 1/30, 6: 1/20, 7: 1/15
- Material symbol**
Refer to the material table (ex. VC, VH, VS4, TC, S6, S4)
- Connection**
None: Flange ("JIS" or others), T: Flange ("DIN"), H: Hose

Specifications

Model	Capacity L/min <small>Note 1</small>	Max. Pressure MPa			Stroke speed spm	Effective diaphragm dia. mm	Max. stroke length mm	Connection				Motor output (4 Pole)
		PVC, PVDF	SUS	Flange				Hose				
				PVC, PVDF				SUS	PVC	PVDF <small>Note 2</small>		
LK-F11	0.02	1.0	1.5	48	22	1.5	DN15 (DIN PN10)	DN15 (DIN PN16)	ID4mm (or 5mm) OD9mm	–	0.25kW	
F21	0.05	1.0	1.5	48	30	2.0						
F22	0.10	1.0	1.5	96	30	2.0						
F31	0.25	1.0	1.5	48	60	2.5			ID12mm OD18mm	–		
F32	0.50	1.0	1.5	96	60	2.5						
F45	0.85	1.0	1.5	48	72	6.0						
F47	1.7	0.8	0.8	96	72	6.0	DN25 (DIN PN10)	–	–			
F55	2.8	0.5	0.5	48	100	10						
F57	6.0	0.3	0.3	96	100	10						
LK-A55	2.8	0.7	0.7	48	100	10	DN25 (DIN PN10)	–	–	0.37kW		
A57	6.0	0.5	0.5	96	100	10						
A65	9.0	0.2	0.2	48	138	17.5						
LK-B65	9.0	0.5	0.7	48	138	17.5	DN40 (DIN PN10)	–	–	0.75kW		
B75	13.3	0.5	0.5	48	150	20	DN50 (DIN PN10)					
LK-C76	20.0	0.5	0.5	72	150	20	DN50 (DIN PN10)	–	–	1.5kW		
C86	33.0	0.3	0.3	72	205	20	DN65 (DIN PN10)					
C87	45.0	0.3	0.3	96	205	20						

Note: The capacity is the value when maximum discharge pressure is applied (with pure water at room temperature).
The value may be larger than indicated in the table if the discharge pressure is lower.

- Standard accessory : A siphon preventing valve, strainer and 4m PVC tube are furnished to hose connection type of LK-F11 to LK-F45VCH or VHH. A base is furnished to all LK-A, LK-B and LK-C models.
- Frequency control is applicable. Please contact us for details.

Dimensions in mm

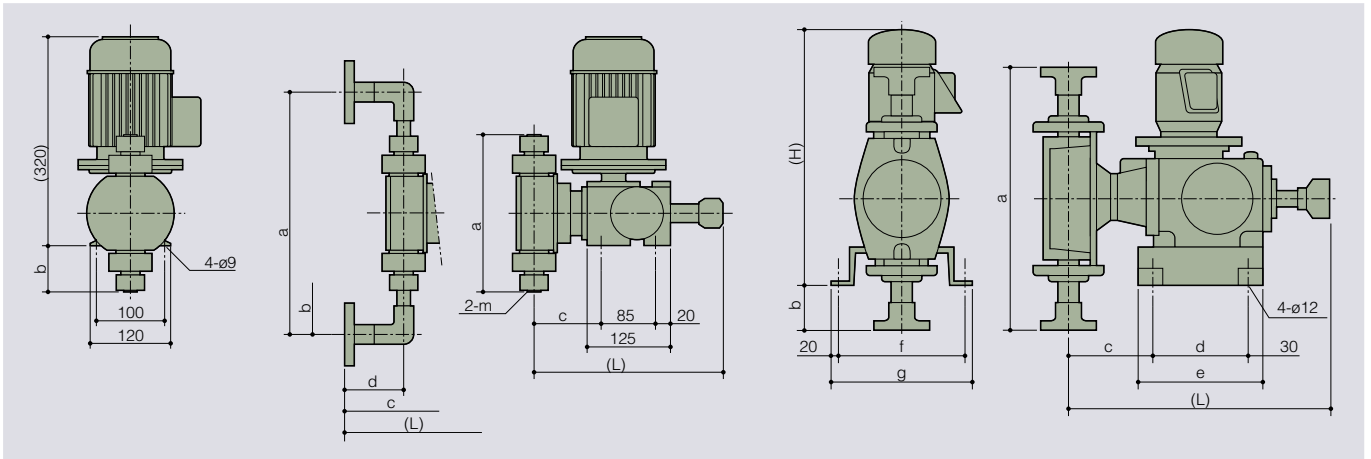

Note: All illustrations above show "PVC" type. The suction flange made of SUS is straight.

LK-F11 to LK-F57

Model	Hose type					Flange type								
	PVC					PVC				SUS				
	L	a	b	c	m	L	a	b	c	d	L	a	b	c
LK-1	275	146	23	95	Note	(363)	272	86	94	89	332	156	20	92
2	275	164	32	95		(363)	290	95	94	89	332	166	25	92
3	277	224	62	97		(366)	350	125	97	89	337	201	42	97
4	281	243	72	99		(370)	369	135	99	89	343	270	80	101
5	-	-	-	-		(395)	350	125	114	97	399	368	110	111

Note: Connection size LK-1, LK-2 $\phi 4 \times \phi 9$ and LK-3, LK-4 $\phi 12 \times \phi 18$.
For information of TC type, please contact IWAKI or nearest distributor.

Dimensions and configurations may be changed without prior notice for the purpose of product improvement.
Be sure to carry out installation work with the most recent and detailed drawings which are available upon request.
The dimensions may differ with the type of motor installed.

LK-A55 to LK-C87

Model	PVC				SUS				Note				
	L	a	b	c	L	a	b	c	H	d	e	f	g
	LK-A5	476	325	-29	111	473	320	-32	108	547	180	240	260
A6	523	599	108	154	533	431	24	164	547	180	240	260	300
B6	595	599	90	164	605	431	6	174	594	240	300	310	350
B7	599	600	90	167	610	465	23	178	594	240	300	310	350
C7	599	600	90	167	610	465	23	178	601	240	300	310	350
C8	605	647	114	173	609	633	107	177	601	240	300	310	350

Note: These dimensions are common between PVC pump head and SUS pump head.
For information of TC type, please contact IWAKI or nearest distributor.

Points to be observed in pump installation and piping

Iwaki metering pump LK series are reciprocating pumps employing the eccentric cam system. Reciprocating pumps generate pulsation in the suction and discharge piping. Special consideration, (different from the ordinary centrifugal pumps), should be given to this point when planning the pump installation and piping.

• Prevention of pipe vibration

Discharge side inertial resistance $P_{id} < 0.1\text{MPa}$
• P_{id} : Inertial resistance on discharge side

Inertial resistance means the pulsated impact force generated by the flow just upon entering discharge stroke. It is a phenomenon particular to a reciprocating pump which is generated as a result of the sudden application of acceleration to the liquid in the discharge piping.

The condition " $P_{id} < 0.1\text{MPa}$ " is given above as an approximate standard. If P_{id} becomes 0.1MPa or higher, vibration on the pipe is generated. So measures should be taken to cope with the influence of vibration on the pump, too.

Measures

1. Install pulsation prevention device (air chamber).
2. Enlarge the diameter and shorten the length of the discharge piping.

• Prevention of overfeeding

Pump differential pressure > Inertial resistance P_i
• The larger one of the suction side or the discharge side

Overfeeding means excessive flow of the liquid due to abnormal functioning of the check valve caused by pulsation of the liquid in the piping. Check carefully in case the differential pressure is low and in case the piping is too long even with the differential pressure value at 0.03MPa .

Measures

1. Install air chamber.
2. Install back pressure valve

• Prevention of suction failure

$NPSH_a > NPSH_r$
 $NPSH_a = P_a - P_v \pm P_{hs} - P_{is} \text{ * MPa}$
*Or P_{fs} : whichever is the larger.
(NPSH : Net positive suction head)

If $NPSH_a$ is not sufficient, the pump may be damaged by the flow-break or cavitation generated under such conditions.

- $NPSH_a$: Absolute NPSH (MPa)
- $NPSH_r$: Required NPSH (value particular to the pump) (MPa)
- P_a : Absolute pressure onto the tank liquid surface (MPa)
- P_v : Liquid vapour pressure (MPa)
- P_{hs} : Pressure caused by the height of the suction side (MPa)
(Flooded suction : +, Negative suction : -)
- P_{is} : Inertial resistance on the suction side (MPa)
- P_{fs} : Piping resistance on the suction side (MPa)

Optional accessories

Siphon preventing valve



Model	BVC-1P□-□H	BVC-1P□-□H
Applicable capacity	Up to 1L/min	
Setting pressure	0.05 - 0.3MPa	0.3 - 0.8MPa
Material	PVC, FKM (EPDM)	
Connection mm (Applicable tube diameter)	Inlet 4 x 9, 12 x 18	Outlet R3/8 and R1/2

□: Symbol for material of O-ring ("V" for FKM, "E" for EPDM)

Air chamber



PVC, A Type

PVC, N Type

SUS, A Type

SUS, A Type

Body	Model	Applicable capacity L	Setting pressure MPa	Connection Nominal size DIN PN10 flange	Weight kg
PVC	A-1V□-S	1.0	0.5	Common for 15 - 25	2
	A-2V□-S	2.0			2.5
	A-5V□-S	5.0			4.5
	N40A-10V(2)-FS *	10			16
	N50A-20V(2)-FS *	20			26
SUS316	A-05S6-15S	0.5	0.9	15, 25, 40, 50, 65	3
	A-1S6-() S	1.5			5
	A-5S6-() S	5.0			12
	A-10S6-() S	10			15
	A-20S6-() S	20			29
	A-36S6-() S	36			55

* : Materials of O-rings: "CR" for 10V / 20V and "FKM" for 10V2 / 20V2

□: Symbol for material of O-ring ("V" for FKM, "E" for EPDM)

() : Symbol for connection (10, 15, 20, 25, 40, 50 or 65)

Note1: The weight is the value of the product only. (The weight of liquid applied is not included.)

Note2: Rigid PVC chamber may deteriorate with ultraviolet ray or the applied chemical liquid over a long period of time. The chamber should be replaced every three years to guarantee safety.

Relief valve and back pressure valve

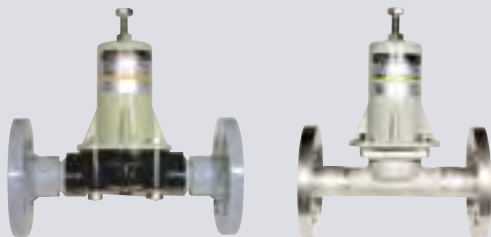

PVC Type

SUS Type

List of relief valve

Body	Model	Max. capacity L/min	Setting pressure MPa	Connection Nominal size DIN PN10 flange, unless otherwise specified	Weight kg
PVC	RV-1P□-4H	1.0	0.3 - 0.8	ø4 x ø9 PVC Hose	0.2
	RV-1P□-12H	1.0	0.3 - 0.8	ø12 x ø18 PVC Hose	0.2
	RV-1P□-15S	1.0	0.3 - 0.8	15	0.5
	RV-1P□B-15S	1.0	0.8 - 1.0	15	0.5
	RV-3P-15S	3.0	0.3 - 1.0	15	0.6
	RV-3P-25S	3.0	0.3 - 1.0	25	0.9
	RV-3P□-12H	3.0	0.3 - 1.0	ø12 x ø18 PVC Hose	0.4
	RV-7V-25S	7.5	0.3 - 0.8	25	3.5
	RV-7VB-25S	7.5	0.8 - 1.0	25	3.5
	RV-25V-25S	25	0.3 - 0.8	25	4.0
	RV-25V-40S	25	0.3 - 0.8	40	4.0
	N50RV-5V-FS	45	0.15 - 0.5	50	18
	N50RV-5V2-FS	45	0.15 - 0.5	50	18
	N65-50RV-5V-FS	65	0.15 - 0.5	65	18
	N65-50RV-5V2-FS	65	0.15 - 0.5	65	18
SUS	RV-2S6-15S	2.0	0.3 - 0.8	15	3.5
	RV-2S6B-15S	2.0	0.8 - 1.5	15	3.5
	RV-7S6-25S	7.5	0.3 - 0.8	25	6
	RV-7S6B-25S	7.5	0.8 - 1.5	25	6
	RV-25S6-25S	25	0.3 - 0.8	25	7.0
	RV-25S6B-25S	25	0.8 - 1.0	25	7.0
	RV-25S6-40S	25	0.3 - 0.8	40	7.5
	RV-25S6B-40S	25	0.8 - 1.0	40	7.5
	N50RV-5S6-FS	75	0.15 - 0.5	50	29
	N65RV-5S6-FS	120	0.15 - 0.5	65	42

□: Symbol for material of O-ring ("V" for FKM, "E" for EPDM)

O-ring material of N type is FKM for "5V2".

Note: Material for diaphragm is PTFE except RV-1P and N type.

O-Ring material for "RV-1P" and "N" type is same as diaphragm material.

List of back pressure valve

Body	Model	Flow range L/min	Setting pressure MPa	Connection Nominal size DIN PN10 flange, unless otherwise specified	Weight kg
PVC	BV-1P□-4H	0.005 - 1.0	0.3 - 0.8	ø4 x ø9 PVC Hose	0.2
	BV-1P□-12H	0.005 - 1.0	0.3 - 0.8	ø12 x ø18 PVC Hose	0.2
	BV-1P□-15S	0.005 - 1.0	0.3 - 0.8	15	0.5
	BV-1P□L-4H	0.005 - 1.0	0.05 - 0.3	ø4 x ø9 PVC Hose	0.2
	BV-1P□L-12H	0.005 - 1.0	0.05 - 0.3	ø12 x ø18 PVC Hose	0.2
	BV-1P□L-15S	0.005 - 1.0	0.05 - 0.3	15	0.5
	BV-3P□-12H	0.03 - 3.0	0.1 - 0.8	ø12 x ø18 PVC Hose	0.4
	BV-3N□-12H	0.03 - 3.0	0.1 - 0.3	ø12 x ø18 PVC Hose	0.4
	BV-3P-15S	0.03 - 3.0	0.1 - 0.8	15	0.6
	BV-3P-25S	0.03 - 3.0	0.1 - 0.8	25	0.9
	BV-7V-25S	0.2 - 7.5	0.05 - 0.8	25	3.5
	BV-25V-25S	2 - 25	0.1 - 0.8	25	4.0
	BV-25V-40S	2 - 25	0.1 - 0.8	40	4.0
	N50BV-5V-FS	2.5 - 50	0.15 - 0.5	50	20
	N50BV-5V2-FS	2.5 - 50	0.15 - 0.5	50	20
	N65-50BV-5V-FS	5 - 70	0.15 - 0.5	65	20
	N65-50BV-5V2-FS	5 - 70	0.15 - 0.5	65	20
	SUS	BV-2S6-15S	0.02 - 2.0	0.05 - 0.8	15
BV-7S6-25S		0.2 - 7.5	0.05 - 0.8	25	6
BV-25S6-25S		2 - 25	0.1 - 0.8	25	7.0
BV-25S6-40S		2 - 25	0.1 - 0.8	40	7.5
N50BV-5S6-FS		2.5 - 80	0.15 - 0.5	50	29
N65BV-5S6-FS		5 - 120	0.15 - 0.5	65	42

□: Symbol for material of O-ring ("V" for FKM, "E" for EPDM)

O-ring material of N type is CR for "5V" and FKM for "5V2".

Note: Material for diaphragm is PTFE except BV-1P and N type.

O-Ring material for "BV-1P" and "N" type is same as diaphragm material.

Multifunction pump controller for LK-F series metering pumps

Pump controller MFC

The MFC controller is designed specifically for LK-F series metering pumps & offers excellent controllability. Automatic control of pump stroke rate between 0 and 120 spm is possible. The MFC controller automatically monitors the actual stroke feed back signal to enable accurate stroke rate control. The large LCD display and touch keys offer user-friendly operation. A key lock function is also provided for control security. The combination of LK-F series pump with MFC pump controller offers low cost with a wide range of automatic control operation for chemical dosing applications.



Control system

- Capable of analogue input (4~20mA) and pulse input (Dividing/Multiply) operation
- Operating functions of the pump can be monitored via external output signal.
- Easy key touch operation and a large LCD display give good control legibility.
- Display preference of flow rate (L/min) or stroke rate (SPM) is user-selectable.
- Combination of stroke length adjustment with stroke rate enables flow volume control over a wide range of 1:480.
- Various additional functions such as key lock, fast priming and control of external level sensors assist in management of chemical dosing requirements.

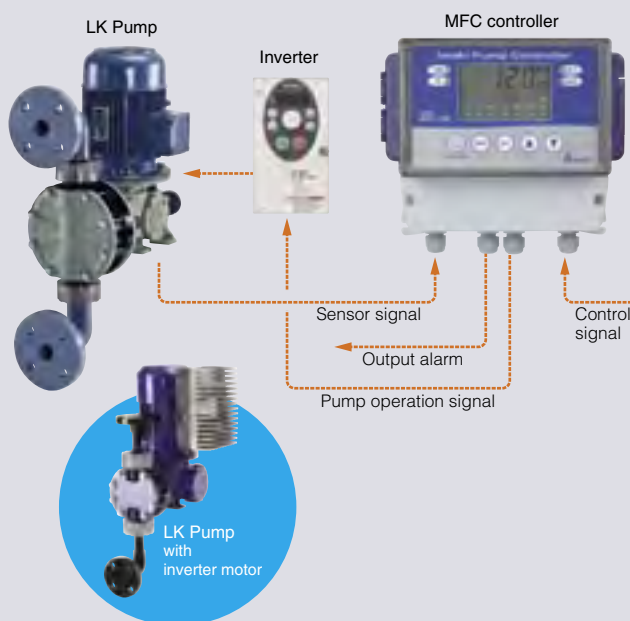

Applicable pump model

Pump model	Stroke rate (spm)	Flow rate range (l/min)	Max. discharge pressure (MPa)	Motor
LK-F11-M	0 - 60	(0.0004) - 0.024	PVC: 1.0 SUS: 1.5	4P 0.37kW
LK-F22-M	0 - 120	(0.001) - 0.120	PVC: 1.0 SUS: 1.5	
LK-F32-M	0 - 120	(0.005) - 0.600	PVC: 1.0 SUS: 1.5	
LK-F47-M	0 - 120	(0.033) - 2.000	0.8	
LK-F57-M	0 - 120	(0.060) - 7.200	0.3	

Note 1. Figures in parentheses are target for the lowest flow rate.

www.iwakipumps.jp

IWAKI CO.,LTD. 6-6 Kanda-Sudacho 2-chome Chiyoda-ku Tokyo 101-8558 Japan TEL : (81)3 3254 2935 FAX : 3 3252 8892

EUROPE / U.S.A.

European office : IWAKI Europe GmbH
 Austria : IWAKI (Austria) GmbH
 Belgium : IWAKI Belgium N.V.
 Denmark : IWAKI Nordic A/S
 Finland : IWAKI Suomi Oy
 France : IWAKI France S.A.
 Germany : IWAKI Europe GmbH
 Holland : IWAKI Holland B.V.
 Italy : IWAKI Italia S.R.L.
 Norway : IWAKI Norge AS
 Spain : IWAKI Iberica Pumps, S.A.
 Sweden : IWAKI Sverige AB
 Switzerland : IWAKI (Schweiz) AG
 U.K. : IWAKI Pumps (UK) Ltd.
 U.S.A. : IWAKI America Inc.

TEL: (49)2154 9254 0
 TEL: (41)26 674 93 00
 TEL: (32)13 67 02 00
 TEL: (45)48 24 2345
 TEL: (358)9 2745810
 TEL: (33)1 69 63 33 70
 TEL: (49)2154 9254 50
 TEL: (31)297 241121
 TEL: (39)02 990 3931
 TEL: (47)66 81 16 60
 TEL: (34)943 630030
 TEL: (46)8 511 72900
 TEL: (41)26 674 93 00
 TEL: (44)1743 231363
 TEL: (1)508 429 1440

FAX: 2154 9254 48
 FAX: 26 674 93 02
 FAX: 13 67 20 30
 FAX: 48 24 2346
 FAX: 9 2742715
 FAX: 1 64 49 92 73
 FAX: 2154 9254 55
 FAX: 297 273902
 FAX: 02 990 42888
 FAX: 66 81 16 61
 FAX: 943 628799
 FAX: 8 511 72922
 FAX: 26 674 93 02
 FAX: 1743 366507
 FAX: 508 429 1386

ASIA / OCEANIA

Australia : IWAKI Pumps Australia Pty Ltd.
 China
 Hong Kong : IWAKI Pumps Co., Ltd.
 Shanghai : IWAKI Pumps (Shanghai) Co., Ltd.
 Guangzhou : GFTZ IWAKI Engineering & Trading Co., Ltd.
 Beijing : GFTZ Iwaki Engineering & Trading Co., Ltd. (Beijing office)
 Korea : IWAKI Korea Co., Ltd.
 Malaysia : IWAKI M Sdn. Bhd.
 Singapore : IWAKI Singapore Pte Ltd.
 Indonesia : IWAKI Singapore (Indonesia Branch)
 Taiwan : IWAKI Pumps Taiwan Co., Ltd.
 Thailand : IWAKI (Thailand) Co., Ltd.
 Vietnam : IWAKI Pumps Vietnam Co., Ltd.

TEL: (61)2 9899 2411
 TEL: (852)2607 1168
 TEL: (86)21 6272 7502
 TEL: (86)20 8435 0603
 TEL: (86)10 6442 7713
 TEL: (82)2 2630 4800
 TEL: (60)3 7803 8807
 TEL: (65)6316 2028
 TEL: (62)21 6906606
 TEL: (886)2 8227 6900
 TEL: (66)2 322 2471
 TEL: (84)613 933456

FAX: 2 9899 2421
 FAX: 2607 1000
 FAX: 21 6272 6929
 FAX: 20 8435 9181
 FAX: 10 6442 7712
 FAX: 2 2630 4801
 FAX: 3 7803 4800
 FAX: 6316 3221
 FAX: 21 6906612
 FAX: 2 8227 6818
 FAX: 2 322 2477
 FAX: 613 933399

()Country codes

Caution for safety use: Before use of pump, read instruction manual carefully to use the product correctly.

Actual pumps may differ from the photos. Specifications and dimensions are subject to change without prior notice. For further details please contact us.