



MVE 700/3

Three Phases - 2 poles - 3000 RPM - 50 Hz
230/400 Volt



Mechanical Features		Electric Features	
General		General	
Working Moment	14.9 kgcm	Nominal Voltage	Δ : 230 V Y : 400 V
Unbalance	7.45 kgcm	Input Power	0.66 kW
FC	758 kg	Current A Max	Δ : 2.17 A Y : 1.25 A
Bearings		Power factor	0.83
TYPE (SKF)	6306 2Z	Ia/In	4,3
	100% 1280	Certification	
Life(h)	80%: 2500	ETL CLASS II DIV.II GROUP F,G TENV NEMA 4	T4
	50%: 10239	ATEX II 3D Ex tc IIIC Tx IP66	T 100°
Bearing Grease		Amb Temp.	-20 ≤ T°C ≤ + 40
Lube Schedule (g)			
Lube Replacement (g)			
Grease Type			

Dimensional Features (mm)

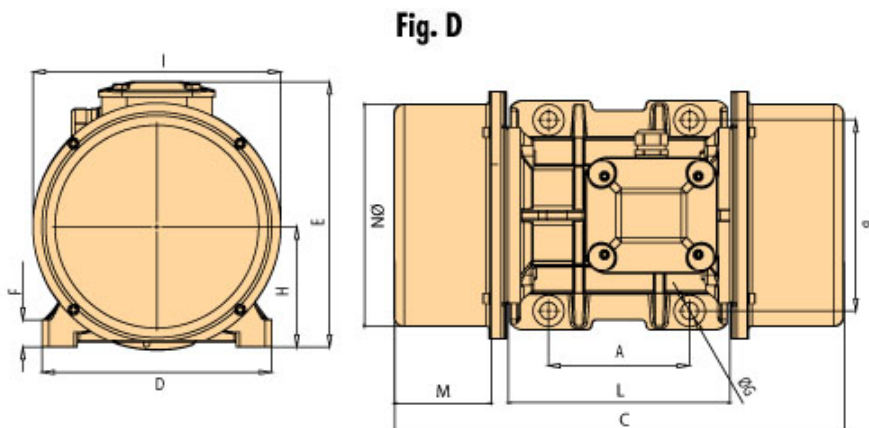

A	105
B	140
C	334
M	78
G	13
holes	4
D	168
E	196
F	22
H	92
I	169
L	178
N	158

Clamping
Torque(Nm)

80

[[Drawings Download](#)]

Weight(kg)	Screw	Washer	Cable Type	Cable Glандe
16.5	M12	13x24	4Gx2.5	M20x1,5

REV.2-03/13/2013